

# EPDS

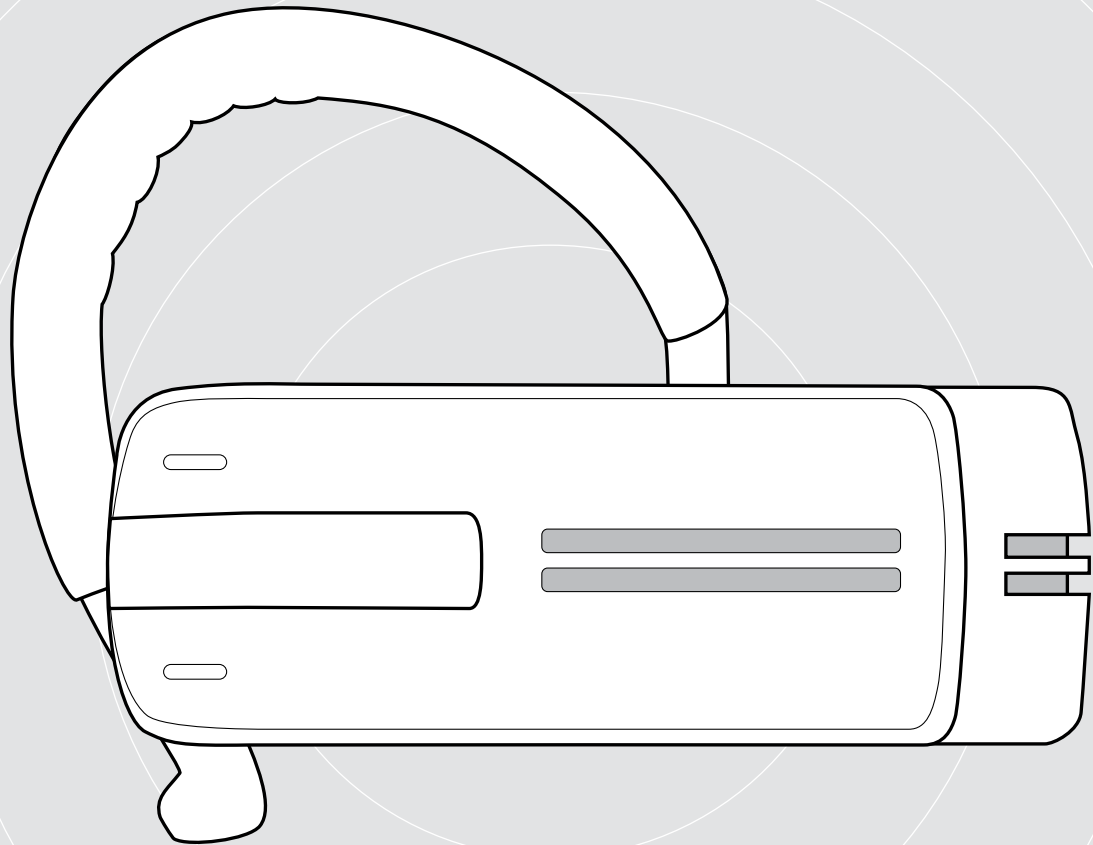

## ADAPT Presence Grey UC

Bluetooth headset for phone calls

User Guide

# Contents

The Presence Grey Bluetooth headset .....	2
Package contents.....	3
Product overview.....	4
Overview of the headset.....	4
Overview of the dongle .....	4
Overview of the LEDs.....	5
Putting the headset into operation .....	6
Charging the headset battery.....	6
Pairing the headset with Bluetooth devices.....	7
Installing the EPOS Connect software.....	10
Changing Audio settings for the headset – Microsoft® Windows .....	10
Using the headset .....	11
Individually adjusting the headset and wearing it.....	11
Switching the headset on and connecting it.....	13
Switching the headset off.....	14
Retrieving information on the remaining talk time.....	14
Changing the volume .....	15
Muting the headset’s microphone.....	16
Enabling/disabling voice prompts.....	16
Storing and transporting the headset.....	17
If you are out of the Bluetooth transmission range.....	17
Making calls using the headset .....	18
Making a call.....	18
Accepting/rejecting/ending a call.....	18
Transferring the call to/from the headset.....	19
Redialing .....	19
Voice dialing for computer or voice assistant for mobile phone.....	19
Managing multiple calls.....	20
Maintaining the products and updating the firmware.....	21
Cleaning the products.....	21
Updating the firmware of the products.....	22
If a problem occurs .....	23

# The Presence Grey Bluetooth headset

The stylish new Presence Grey Bluetooth headset is the wireless solution for phone calls with mobile phones and softphones with superb sound quality in all environments.

It features WindSafe and SpeakFocus technology to filter away background noise and enhance voice quality, thus providing ultimate speech intelligibility.

## Bluetooth

The headset complies with the Bluetooth 4.0 standard and is compatible with all Bluetooth 1.1, 1.2, 2.0, 2.1, 3.0 and 4.0 devices with a “hands free profile” (HFP), a “headset profile” (HSP) or an “advanced audio distribution profile” (A2DP).

The headset provides wireless freedom to give hands-free convenience with your mobile phone.

## Key benefits & features

### WindSafe technology

Intelligent wind noise reduction using three digital microphones working in synergy and filtering away unwanted wind noise

### SpeakFocus technology

Adaptive noise reduction system with 3 digital microphones which is optimized for noisy environments e. g. in a car, outdoors or in the office

### Echo-free conversations

You can quickly take or end calls and adjust the volume to suit you best

### HD quality sound

Crystal-clear, detailed and transparent sound reproduction due to large wideband speaker and extended frequency response

### Lightweight comfort

Headset weighs only 13 grams

### Flexible wearing style

Wear left or right, use with or without ear hook

### Long talk time

Talk to business partners and friends for up to 10 hours, with up to 14 days of standby time

### Noise dependent volume control

Automatic, adaptive volume adjustment for optimized speech intelligibility and sound quality



For safety instructions, consult the Safety Guide.



For specifications, consult the Fact sheet available at [eposaudio.com](http://eposaudio.com)







A list of accessories can be found on the product page at [eposaudio.com](http://eposaudio.com)

## Trademarks

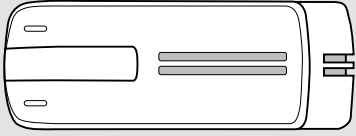
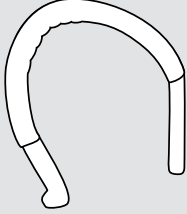
The Bluetooth® word mark and logos are registered trademarks owned by Bluetooth SIG, Inc. and any use of such marks by DSEA A/S is under license. All other trademarks are the property of their respective owners.

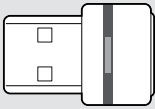
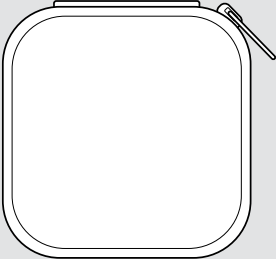
## Package contents

	<p><b>Presence Grey</b> mono Bluetooth headset with built-in rechargeable Lithium-Polymer battery</p>
	<p><b>Ear hook</b> adjustable</p>
	<p><b>Ear adapters</b> S, M, L</p>
	<p><b>Charging cable</b></p>
	<p><b>BTD 800 (USB-A)</b> Bluetooth dongle</p>
	<p><b>Carrying case</b> for headset and accessories</p>
	<p><b>Quick Guide</b> <b>Safety Guide</b> <b>Compliance sheet</b></p>

# Product overview

## Overview of the headset

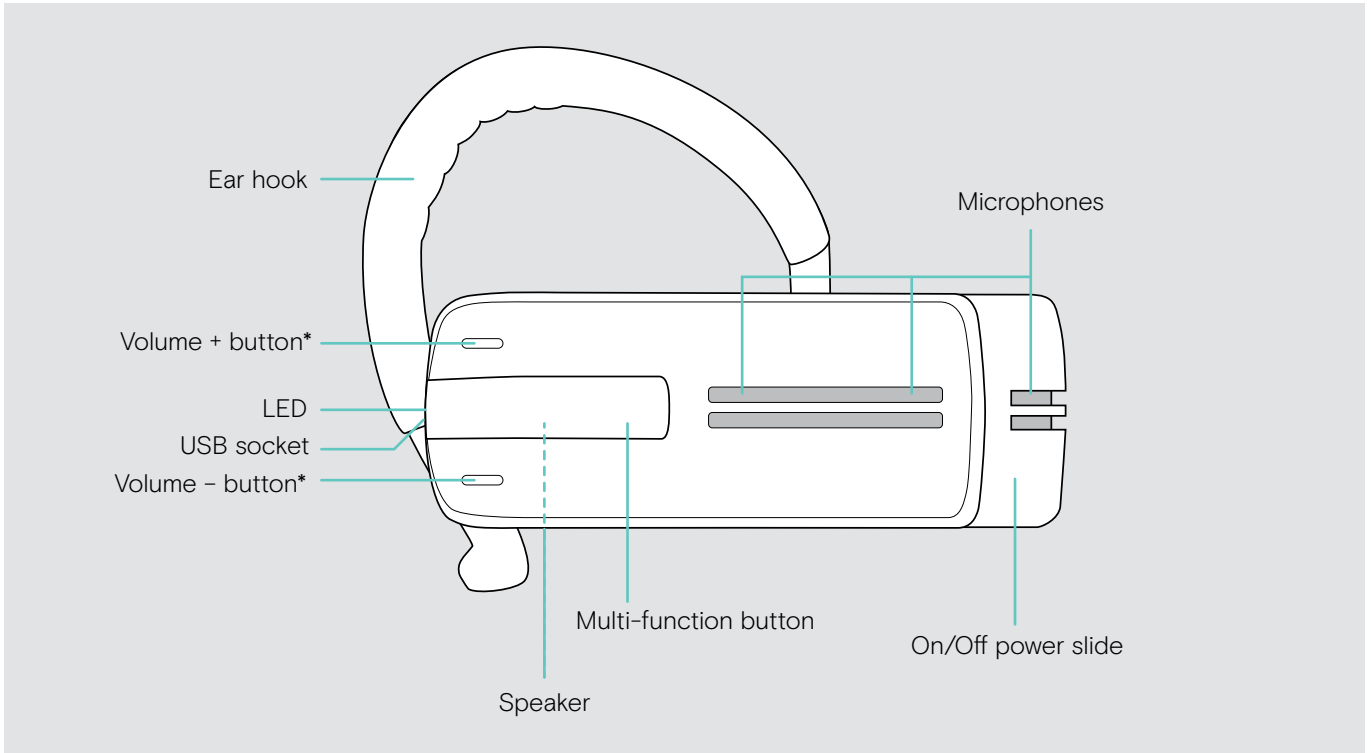





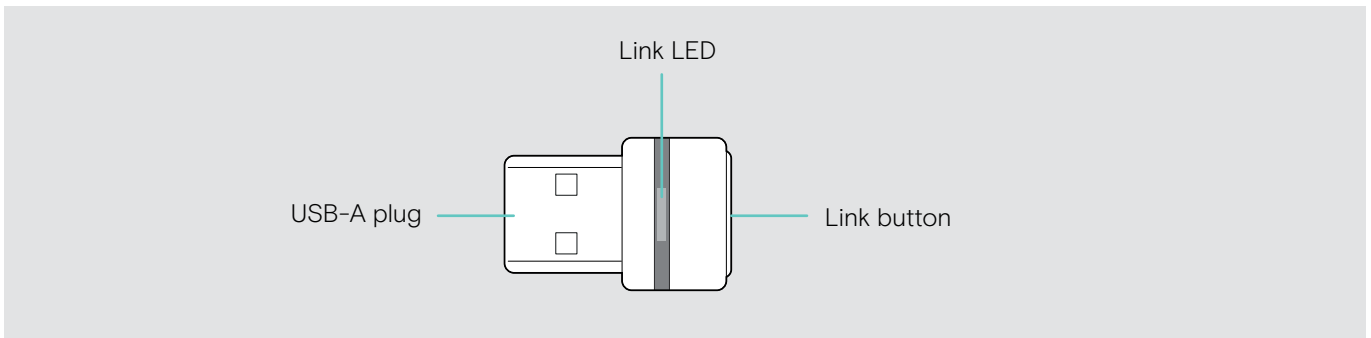





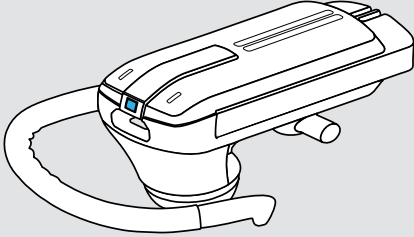







\* You can swap the +/- assignment of the Volume buttons (see page 15)  
If, for example, you want to wear the headset on the left ear instead of the right (see page 11).

## Overview of the dongle













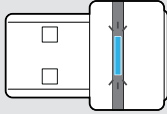





## Overview of the LEDs

### Overview of the headset LED

Headset	LED	Meaning
	↓ 3x  ...	Headset switches on
	↓ 3x  ...	Headset switches off
	↓  ↓  ↓  ↓  ...	Headset is in pairing mode
	↓ 3x  ...	Pairing was successful*
	↓ 3x  ...	Pairing has failed or has been canceled
	↓    2s      2s   ...	Connectable state, not connected
	↓  ↓  ↓  ↓  ...	Incoming call
	↓  ↓  ↓  ↓  ...	Incoming call + rechargeable battery is weak

\*Once the headset is successfully connected, the LED goes off.

### Overview of the dongle LED

Dongle	LED	Meaning
	↓  ↓  ↓  ↓  ...	Dongle in pairing mode: searching for Bluetooth devices to pair and connect
	↓ 3x  ...	Pairing successful
	↓ 3x  ...	Pairing failed
	↓    2s      2s   ...	Dongle tries to connect to a Bluetooth device
	↓  ...	Dongle and Bluetooth device connected
	↓  ...	<ul style="list-style-type: none"> <li>Outgoing/active call</li> <li>Media streaming in standard quality</li> </ul>
	↓    0.2s      0.2s   ...	Incoming call
	↓  ...	Media streaming in high quality
	↓    3s      3s   ...	Microphone of the connected Bluetooth device is muted

# Putting the headset into operation

## Charging the headset battery

**WARNING**  
**Danger of injury!**

Wearing the headset when charging can cause burns and injuries.

> Do not wear the headset when charging.

A complete charging cycle takes about 1 hour and 20 minutes. Before using the headset for the first time, charge the rechargeable battery for a complete charging cycle without interruption.

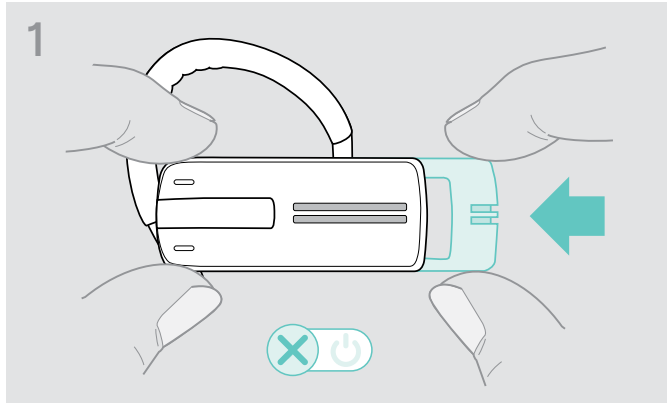

> Gently push the on/off power slide towards the headset. The voice prompt “power off” is announced in the headset and the LED flashes red 3 times.

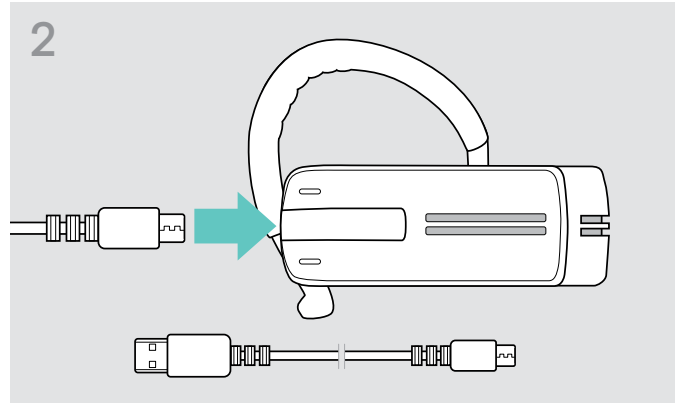

> Connect the micro USB plug of the charging cable to the USB socket of the headset.

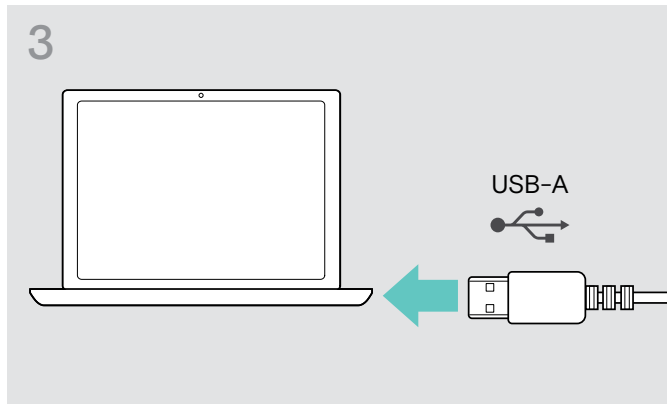

> Connect the USB plug of the charging cable to the USB socket of your computer.

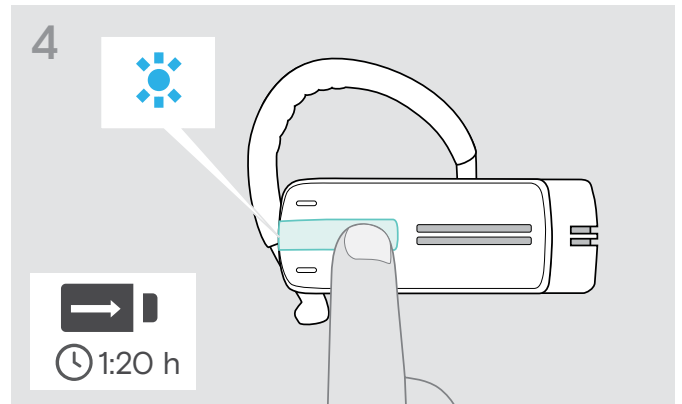

The battery is being charged. The LED flashes depending on the battery charge level. After 5 minutes, the LED goes off.

> Press the multi-function button to check the battery charge level. When the battery is fully charged, the LED lights up blue constantly.

A charging time of ...	corresponds to a talk time of ...	LED flashes
approx. 10 minutes	less than 1 hour	1x 🔴
approx. 20 minutes	between 1 and 2 hours	1x 🔵
approx. 40 minutes	between 2 and 4 hours	2x 🔵
approx. 80 minutes	between 4 and 10 hours	3x 🔵

**i** When the battery charge level drops below 15 minutes of talk time, the LED flashes red and the voice prompt “recharge headset” is announced several times. When the battery is flat, the headset switches off automatically.

### Battery level indicator displayed on Apple iPhone

When the headset is paired with an iPhone, the iPhone screen shows an additional battery level indicator for the headset.

## Pairing the headset with Bluetooth devices



### CAUTION

#### Danger of malfunction!

The transmitted radio waves of mobile phones can impair the operation of sensitive and unprotected devices.

> Only make calls with the headset in locations where wireless Bluetooth transmission is permitted.

The headset complies with the Bluetooth 4.0 standard. In order that data can be transmitted wirelessly using Bluetooth technology, you have to pair your headset with Bluetooth devices that support the “hands free profile” (HFP), the “headset profile” (HSP) or the “advanced audio distribution profile” (A2DP).

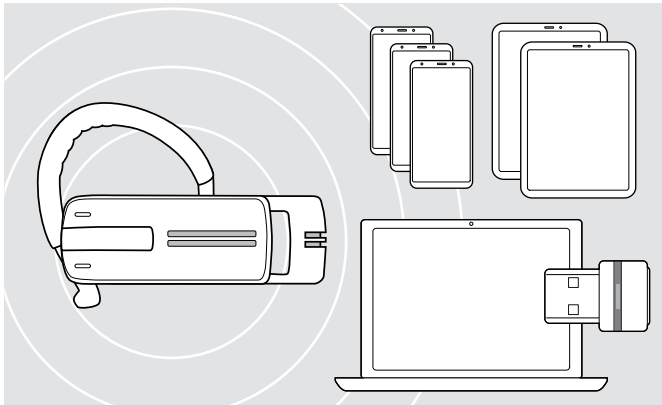

The headset can save the connection profiles of up to eight Bluetooth devices with which it has been paired.

If you pair the headset with a ninth Bluetooth device, the saved connection profile of the least used Bluetooth device will be overwritten. If you want to re-establish a connection with this Bluetooth device, you have to pair the headset again.



After switch-on, the headset automatically tries to connect to the two last connected Bluetooth devices.

You can only connect a third Bluetooth device after having switched off the first or the second Bluetooth device.

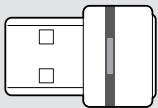

To connect the headset wirelessly with a computer, use the BTD 800 dongle.



### Pairing the headset with a Bluetooth device

By way of example of a mobile phone, the following chapter describes how to pair the headset with a Bluetooth device. In case of deviation, proceed as described in the instruction manual of your mobile phone.

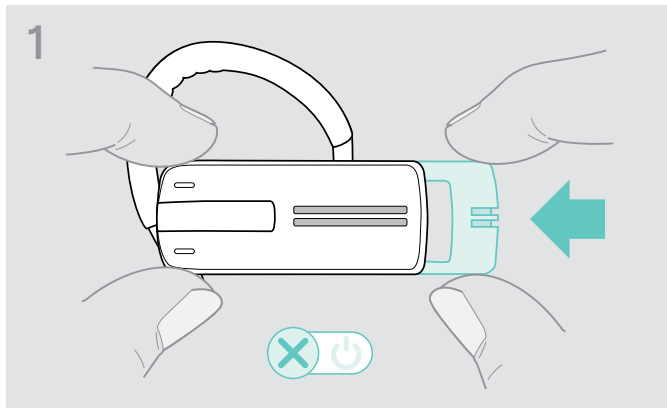

> Gently push the on/off power slide towards the headset. The voice prompt "power off" is announced in the headset and the LED flashes red 3 times.

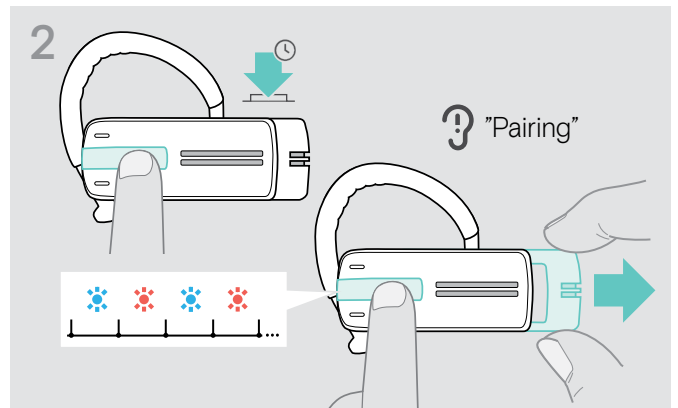

> Keep the multi-function button pressed and gently pull the on/off power slide away from the headset. The LED alternately flashes blue and red. The headset is in pairing mode.

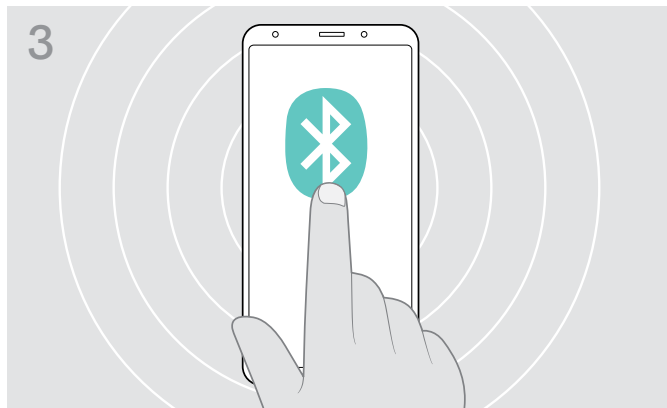

> Enable the Bluetooth visibility on your mobile phone.

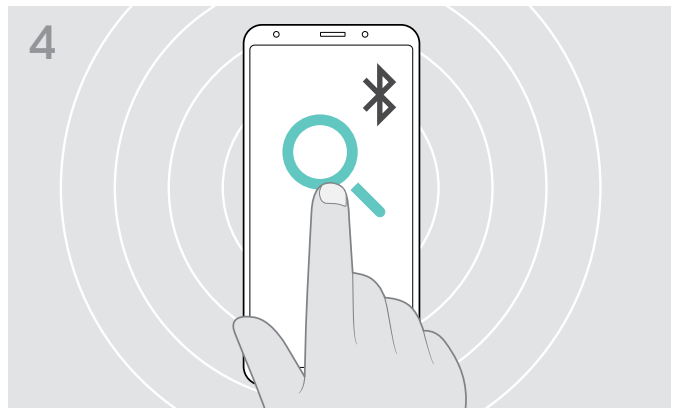

> Start a search for Bluetooth devices. All available devices in the proximity of the mobile phone are displayed.

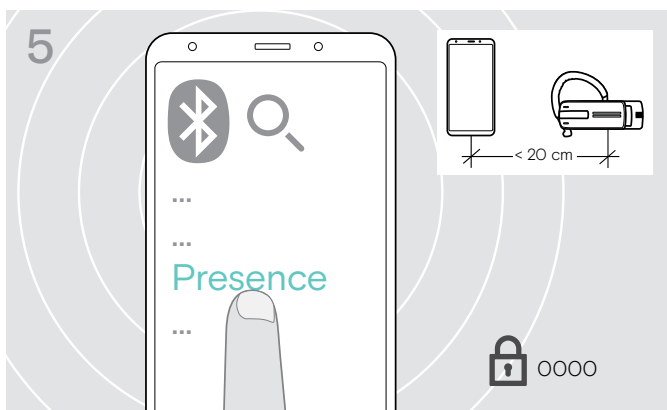

> Select "Presence" to establish a Bluetooth connection to the headset. If necessary, enter the default PIN code "0000".

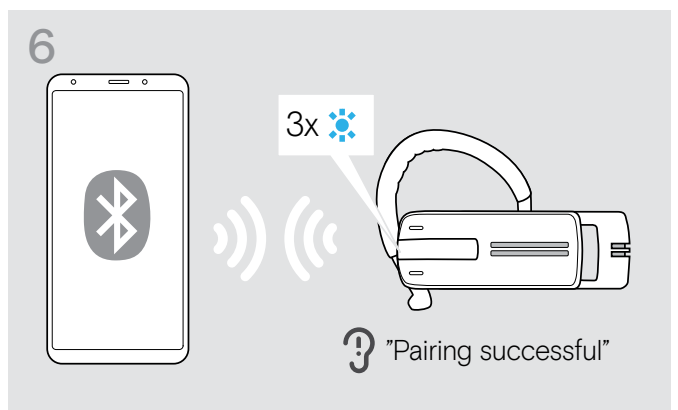

Once the headset is paired with the mobile phone, the LED goes off.

### Using the headset with a computer and a Bluetooth USB dongle

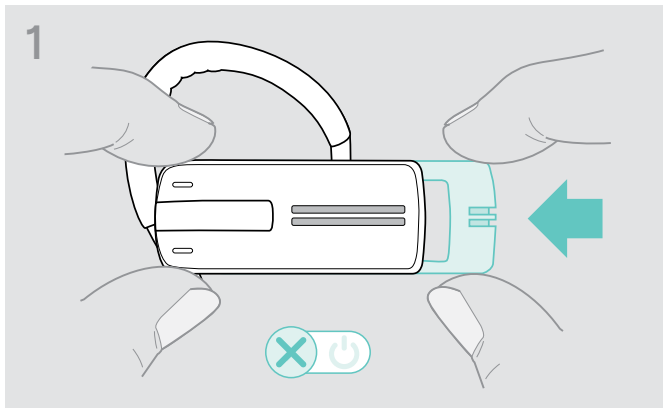

> Gently push the on/off power slide towards the headset. The voice prompt “power off” is announced in the headset and the LED flashes red 3 times.

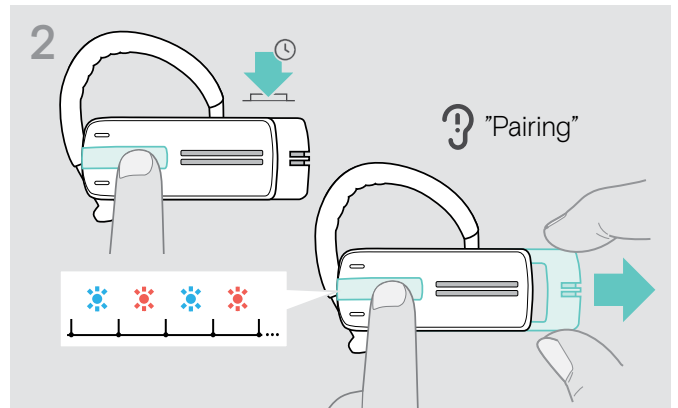

> Keep the multi-function button pressed and gently pull the on/off power slide away from the headset. The LED alternately flashes blue and red. The headset is in pairing mode.

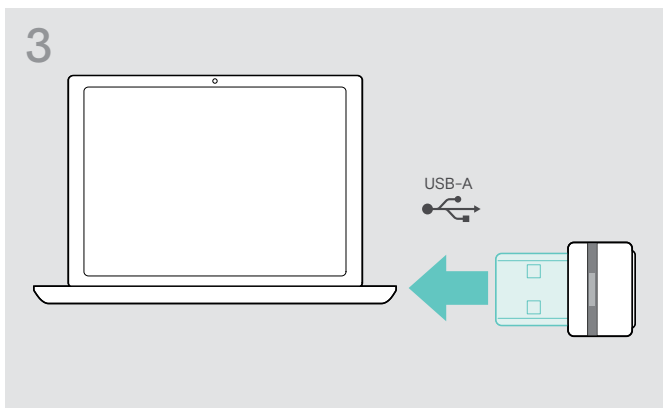

> Plug the Bluetooth USB dongle into the USB port of your computer.

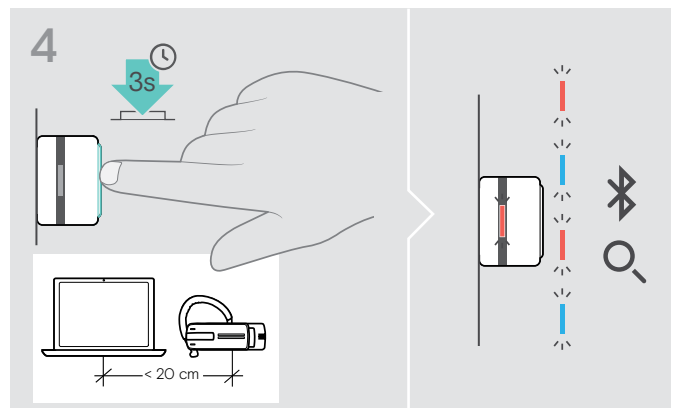

> Press and hold the dongle’s button for 3 seconds to enter pairing mode. The LED alternately flashes blue and red.

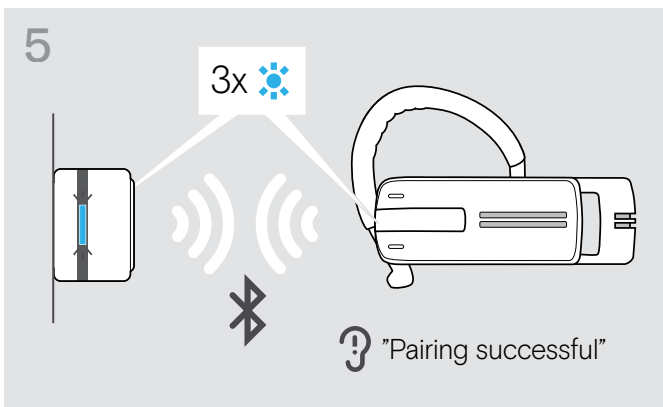

Once the Bluetooth devices are paired, the LED flashes 3 times blue and then lights up in a constant dim blue.

## Installing the EPOS Connect software

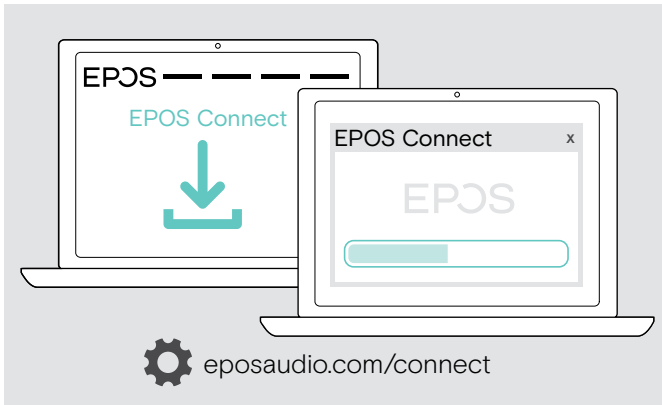

The free **EPOS Connect** software allows you to configure and update your headset and offers additional settings.

- > Download the software from [eposaudio.com/connect](https://eposaudio.com/connect).
- > Install the software.  
You need administrator rights on your computer – if necessary, contact your IT department.

To make calls via the computer:

- > Install a softphone (VoIP Software) or ask your admin for support.

## Changing Audio settings for the headset – Microsoft® Windows

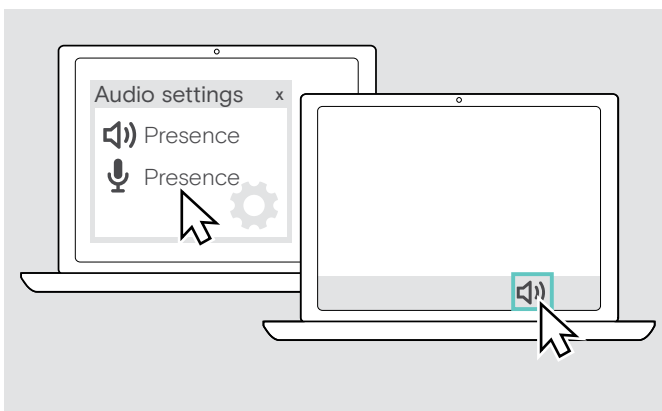

Windows usually changes the Audio settings automatically if you connect a new headset.

If the headset is connected but you hear no sound:

- > Right-click the Audio icon.
- > Select under output Presence as speaker.
- > Select under input Presence as microphone.

# Using the headset

## Individually adjusting the headset and wearing it

For an optimized and individual wearing comfort, the headset can be worn on your left or right ear in three different ways: with the ear hook or the ear adapter or a combination of both.

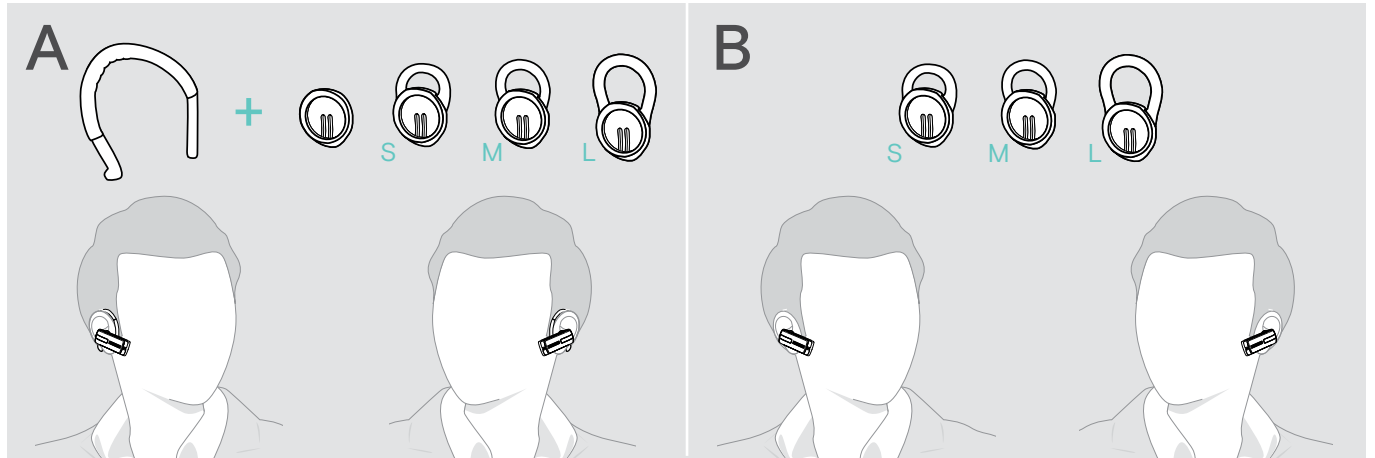

### Wearing the headset with ear adapter

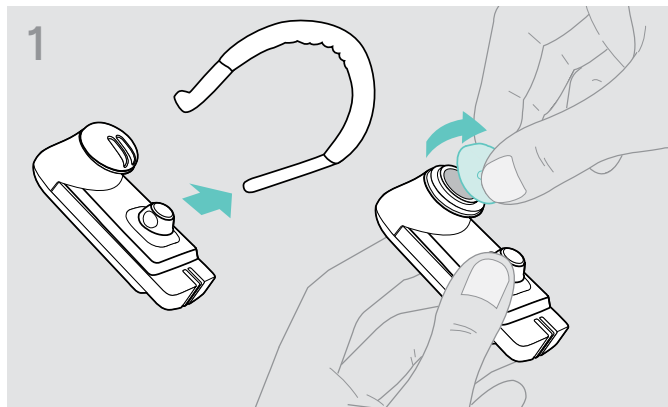

> Remove the ear hook and the ear adapter without loop (premounted) or the ear adapter with loop from the headset.

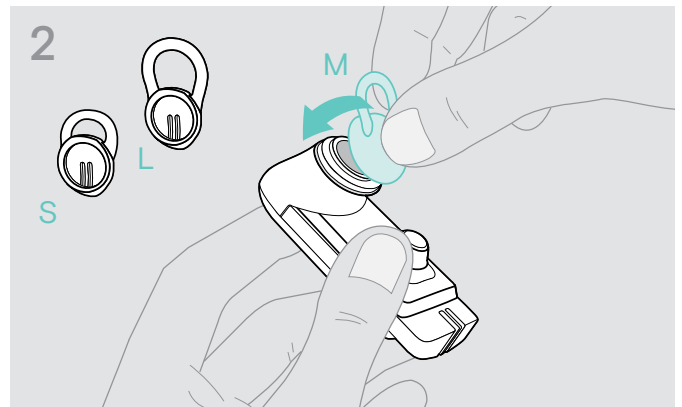

> Attach the selected ear adapter with loop to the headset.

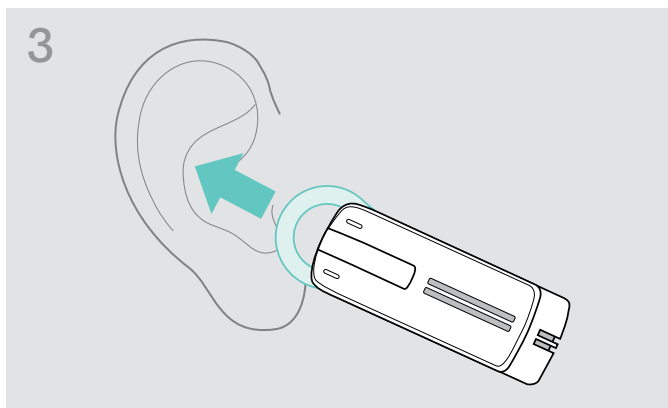

> Move the headset to your ear and insert the loop of the ear adapter.

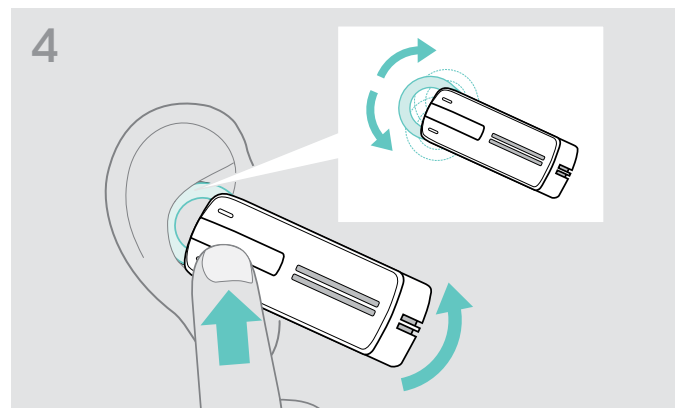

> Adjust the angle of the loop so that the headset fits comfortably and securely in your ear.

### Wearing the headset using the ear hook

You can combine the ear hook with the ear adapter without loop. If then the headset does not fit properly, use one of the ear adapters with loop.

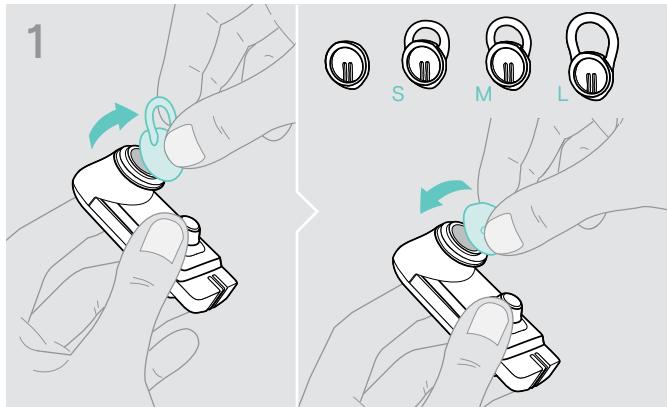

> Remove the ear adapter with loop if necessary and attach the ear adapter without loop, whichever feels most comfortable.

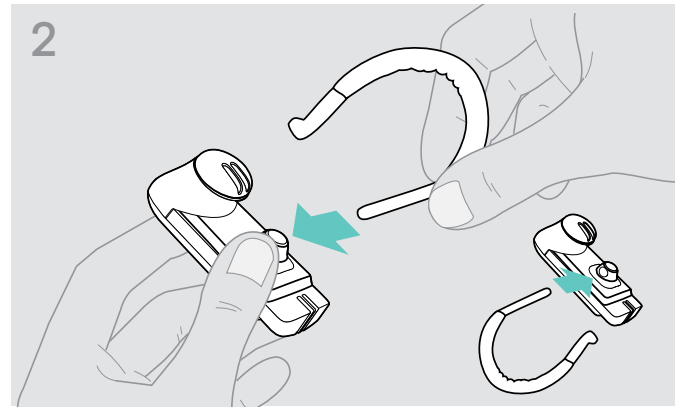

> Attach the ear hook to the headset. If you want to change the wearing ear of the headset, attach the ear hook the other way round.

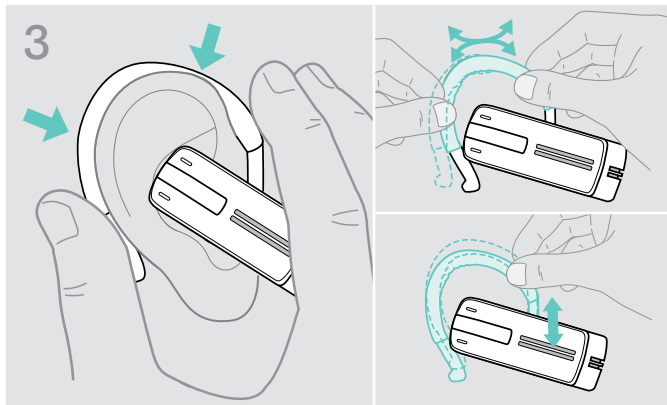

> Move the headset to your ear and guide the ear hook behind your ear. If the headset does not fit optimally, slightly bend the ear hook a bit.

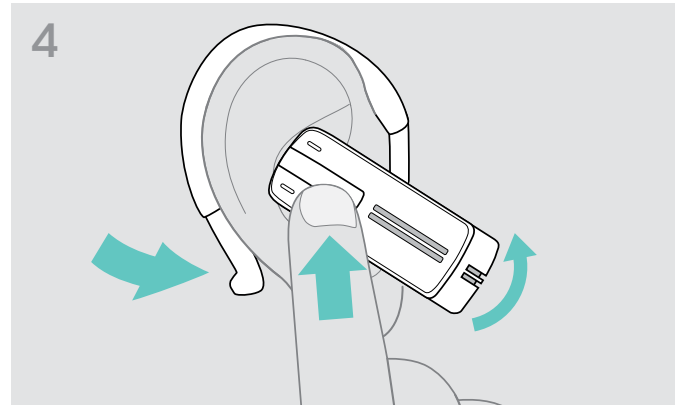

> Position the headset so that it fits comfortably.

### Wearing the headset with the optional headband

The Presence headband is available as an accessory.

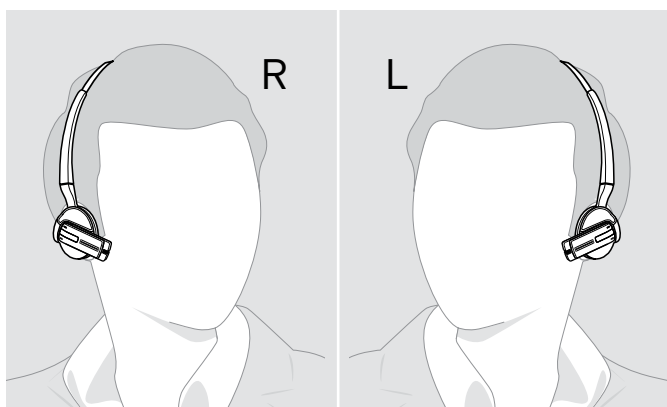

## Switching the headset on and connecting it

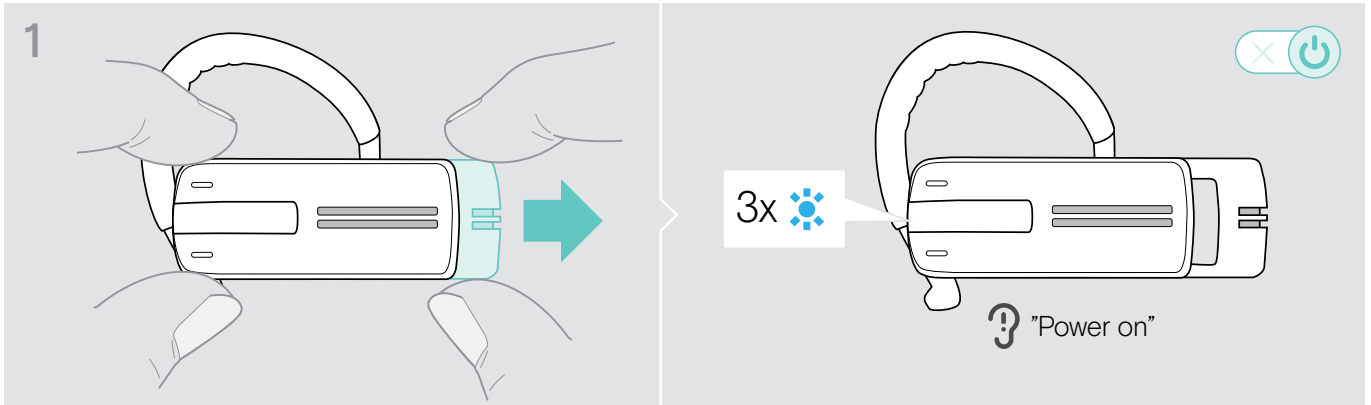

- > Gently pull the on/off power slide away from the headset.  
The LED flashes blue 3 times. The voice prompt “power on” is announced in the headset.

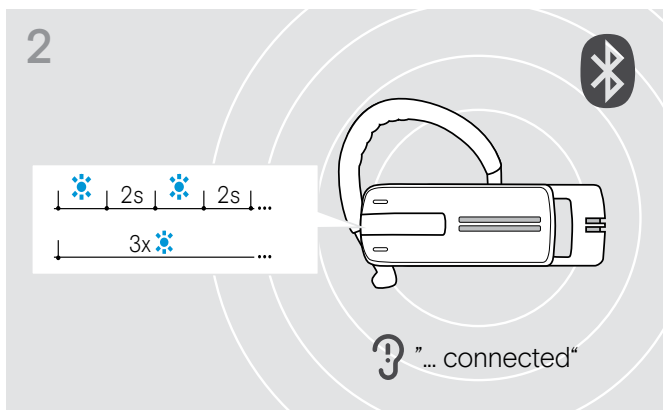

The LED flashes 3 times blue every 2 seconds until the headset finds a paired Bluetooth device to connect to.

Once the connection is successfully established, one or two of the following voice prompts are announced in the headset:

- “Phone one connected” for the first mobile phone
- “Phone two connected” for the second mobile phone or
- “Dongle connected” for the Bluetooth dongle.

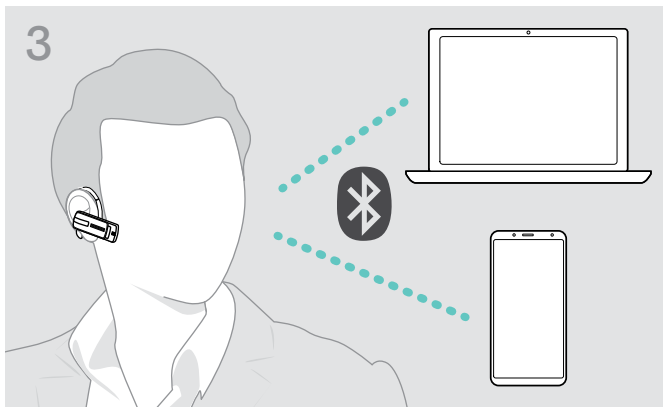

Only two out of the maximum eight paired Bluetooth devices can be simultaneously connected to the headset.

After switch-on, the headset automatically tries to connect to the two last connected Bluetooth devices.

## Switching the headset off

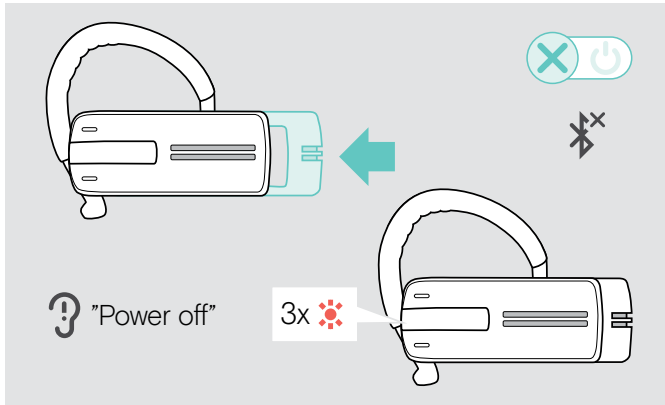

- > Gently push the on/off power slide towards the headset. The voice prompt “power off” is announced in the headset and the LED flashes red 3 times. The headset ends the call and switches off.

All volume settings are saved automatically when the headset is switched off.

## Retrieving information on the remaining talk time

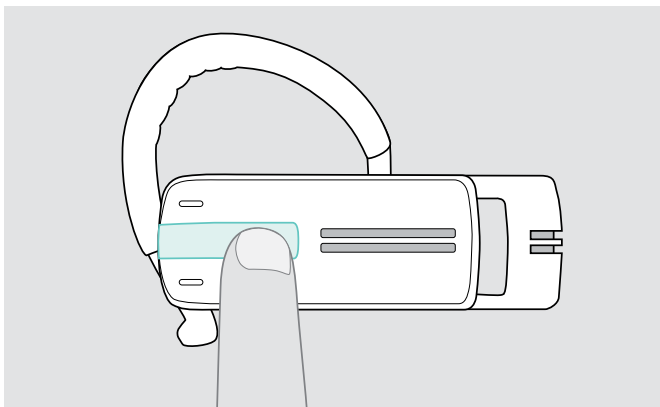

You can retrieve information on the remaining talk time at any time except when you are on a call or listening to media:

- > Press the multi-function button.

Information announced	Remaining talk time	LED flashes
“Between eight and ten hours talk time”	8 to 10 hours	3x
“Between four and eight hours talk time”	4 to 8 hours	3x
“Between two and four hours talk time”	2 to 4 hours	2x
“Between one and two hours talk time”	1 to 2 hours	1x
“Less than one hour talk time”	less than 1 hour	1x
„Recharge headset“	less than 15 minutes talk time; automatic voice prompt > Recharge headset (see page 6).	1x

## Changing the volume



### CAUTION

#### Hearing damage due to high volumes!

Listening at high volume levels for long periods can lead to permanent hearing defects.

- > Set the volume to a low level before putting on the headset.
- > Do not continuously expose yourself to high volumes.

### Swapping the +/- assignment of the Volume buttons

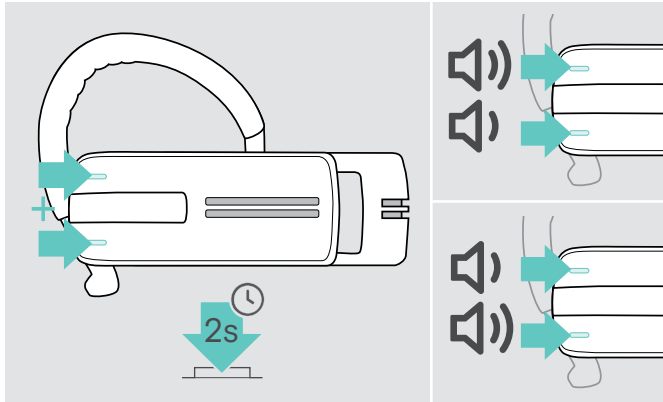

You can swap the +/- assignment of the Volume buttons. If, for example, you want to wear the headset on the other ear (see page 11).

- > Keep both Volume buttons pressed for 2 seconds to swap the +/- assignment of the buttons. The voice prompt “**swap volume keys**” is announced in the headset.

### Changing the volume

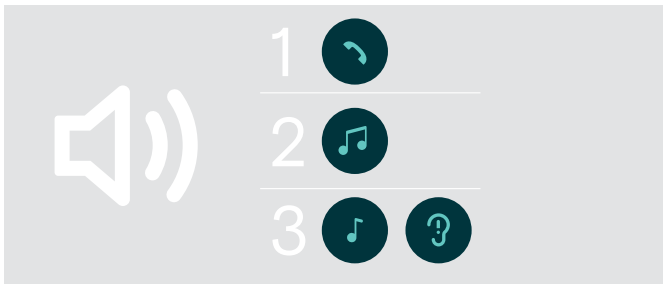

You can adjust three independent volume settings for the headset:

1. speaker volume: can be adjusted during an active call,
2. audio volume: can be adjusted during media reproduction,
3. volume for the ring tone, the beeps and the voice prompts: can be adjusted in idle mode (no active call or media reproduction)

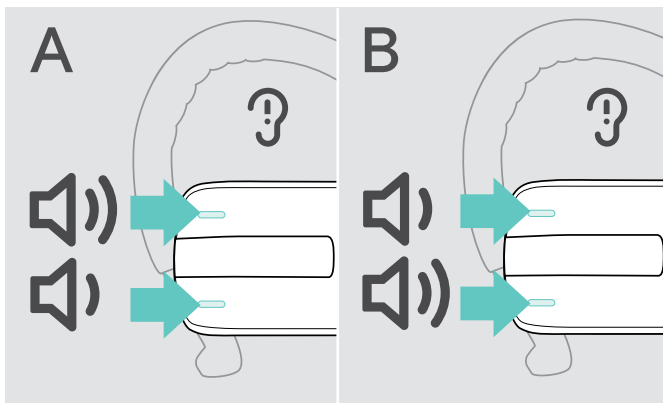

- > Press the
  - Volume + button to increase the volume.
  - Volume - button to reduce the volume.
 When the minimum or maximum volume is reached, the voice prompt “**Volume min**” or “**Volume max**” is announced in the headset. When the voice prompts are disabled, you hear a beep in the headset instead.



## Muting the headset's microphone

### Muting the microphone

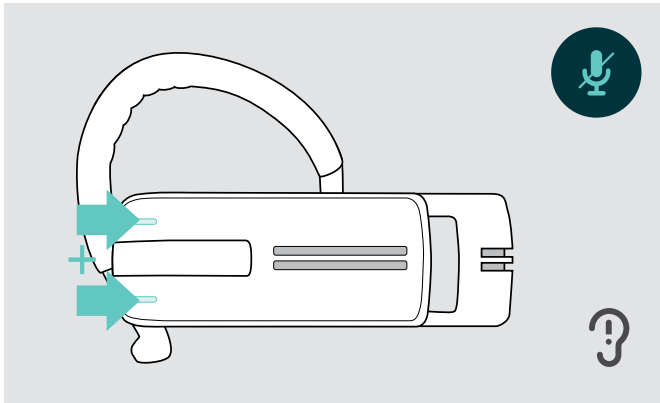

- > Press the Volume + and - button.  
The voice prompt "Mute on" is announced.

### Unmuting the microphone

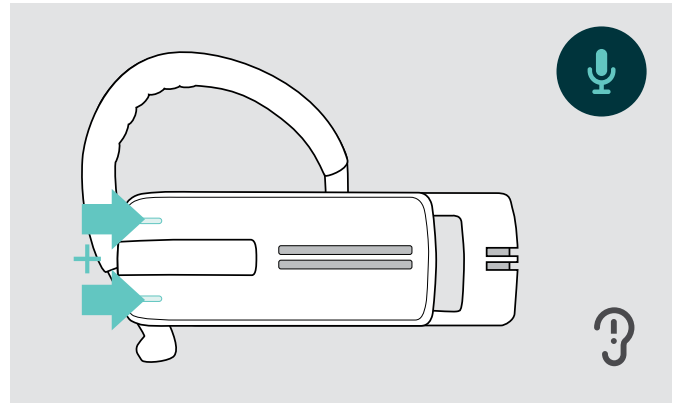

- > Press the Volume + and - button.  
The voice prompt "Mute off" is announced.

## Enabling/disabling voice prompts

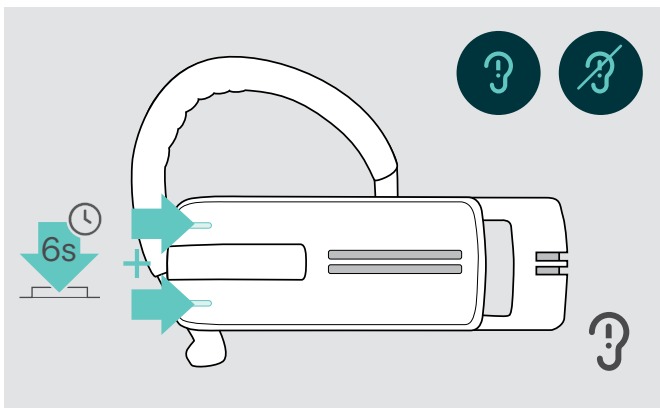

In idle mode (no active call or media reproduction):

- > Press and hold both volume buttons.  
The voice prompts are now activated/deactivated and the voice prompt "Voice on" or "Voice off" is announced in the headset.

## Storing and transporting the headset

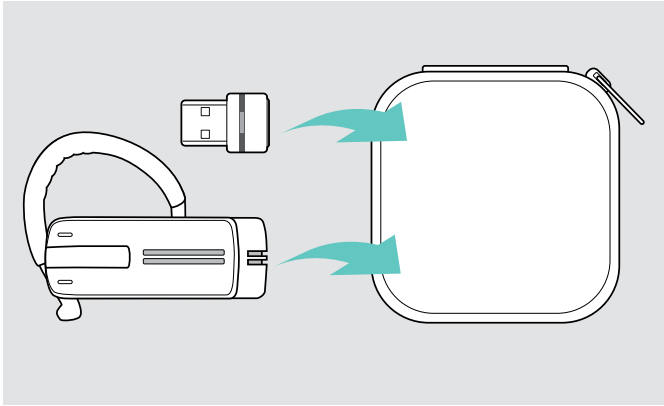

To avoid nicks or scratches on the headset:

- > Store the headset in the case when not in use or when carrying it around.
- > Keep it in a clean and dry environment.

If you do not use the headset for extended periods of time:

- > Charge the built-in rechargeable battery every 3 months for about 1 hour.

## If you are out of the Bluetooth transmission range

Calling is only possible in the Bluetooth transmission range of the mobile phone/Bluetooth device. The transmission range largely depends on environmental conditions such as wall thickness, wall composition etc. With a free line of sight, the transmission range of most mobile phones and Bluetooth devices is up to 25 meters.

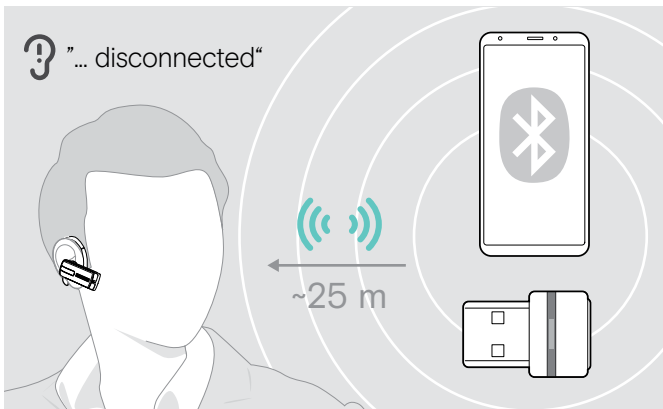

If the headset leaves the transmission range of the connected Bluetooth device during a call, one of the following voice prompts is announced in the headset:

- “Phone one disconnected” for the first mobile phone
- “Phone two disconnected” for the second mobile phone or
- “Dongle disconnected” for the Bluetooth dongle.

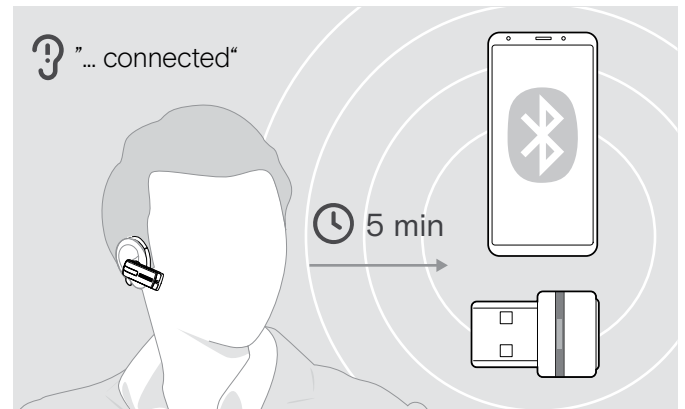

If you re-enter the Bluetooth transmission range **within 5 minutes**, the connection is re-established and the voice prompt “Phone one connected”, “Phone two connected” or “Dongle connected” is announced in the headset.

If you spend **more than 5 minutes** outside the Bluetooth transmission range, the connection breaks down completely and you have to manually re-establish the connection.

# Making calls using the headset

## Making a call

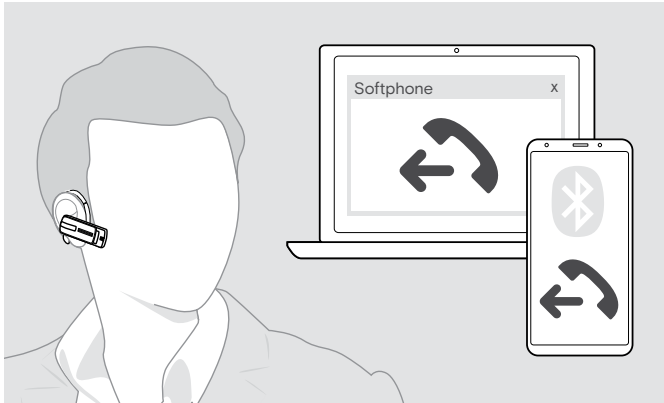

- > Dial the desired number on your mobile phone. You hear a beep in the headset.

If your mobile phone does not automatically transfer the call to the headset:

- > Press the multi-function button once to transfer the call from the mobile phone to the headset. Alternatively, press a button on your mobile phone (see the instruction manual of your mobile phone).

## Accepting/rejecting/ending a call

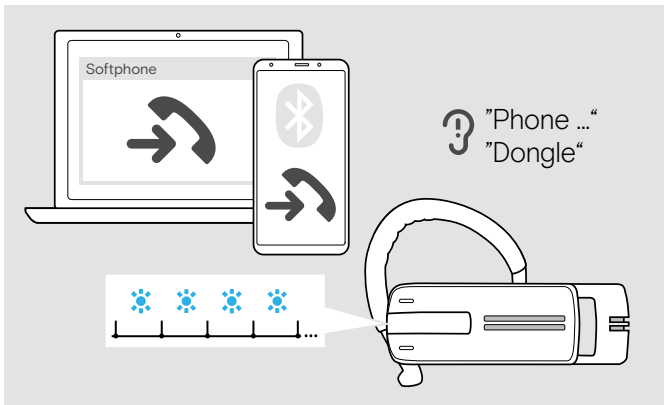

When you receive a call, the headset announces which of the connected Bluetooth device is ringing:

- connected mobile phones: "Phone one" or "Phone two" or
- Bluetooth dongles connected to the computer: "Dongle"

You then hear a ring tone in the headset and the LED flashes blue. If the headset battery is low, the LED flashes red instead of blue.

When you receive a call and your headset is switched off, simply switch your headset on to accept the call.

If you receive and accept a call, the media reproduction is paused and restarts after the call (if the media player supports this feature).

**i** When the voice prompts are disabled, you hear a beep in the headset.

- > Press the multi-function button:

		Accepts a call	
		Rejects a call	"Call rejected"
		Puts an active call on hold (pause)	-
		Ends a call	"Call ended"

## Transferring the call to/from the headset

Once a connection is established, you can transfer the call to/from the headset.

> Press the multi-function button:

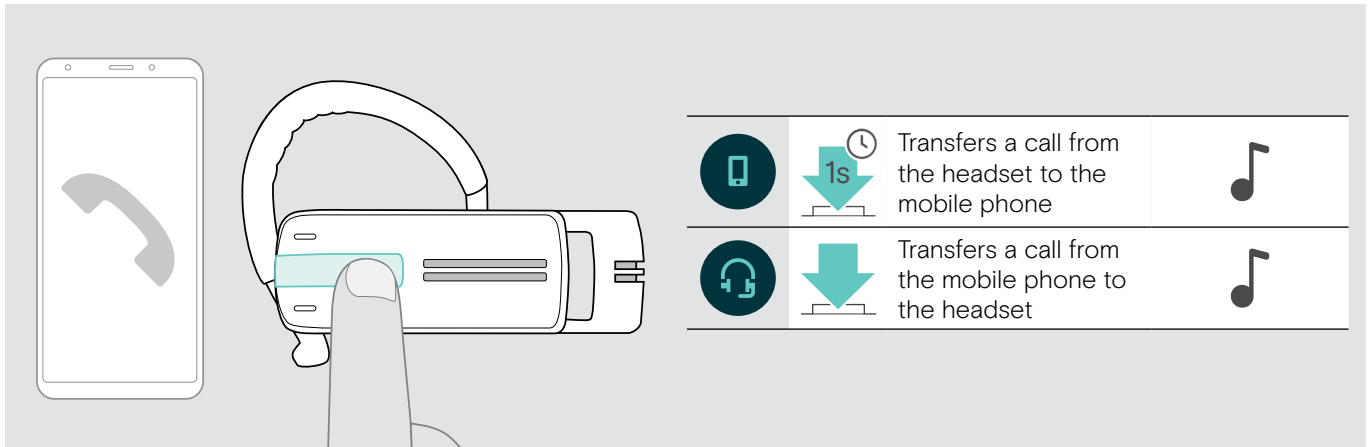

## Redialing

The redialing function is only supported by Bluetooth devices with a “hands free profile” (HFP).

> Press the multi-function button:

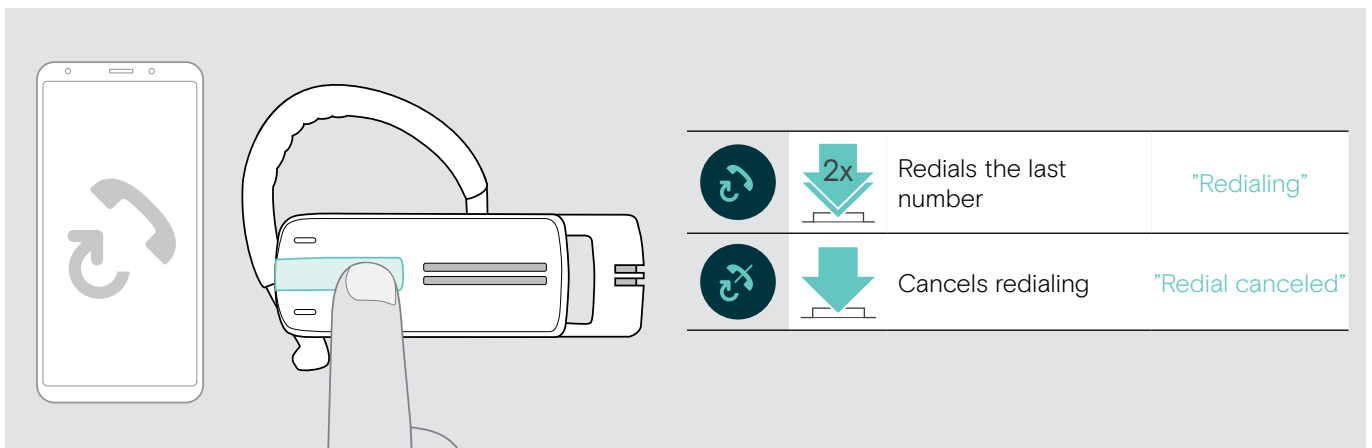

## Voice dialing for computer or voice assistant for mobile phone

The voice dialing function is only supported by Bluetooth devices with a “hands free profile” (HFP). The voice commands and functions depend on the Bluetooth device or on the App. Instead of voice dialing, the voice assistant can be activated on your mobile phone – precondition: the headset is ONLY connected to a mobile phone.

> Press the multi-function button:

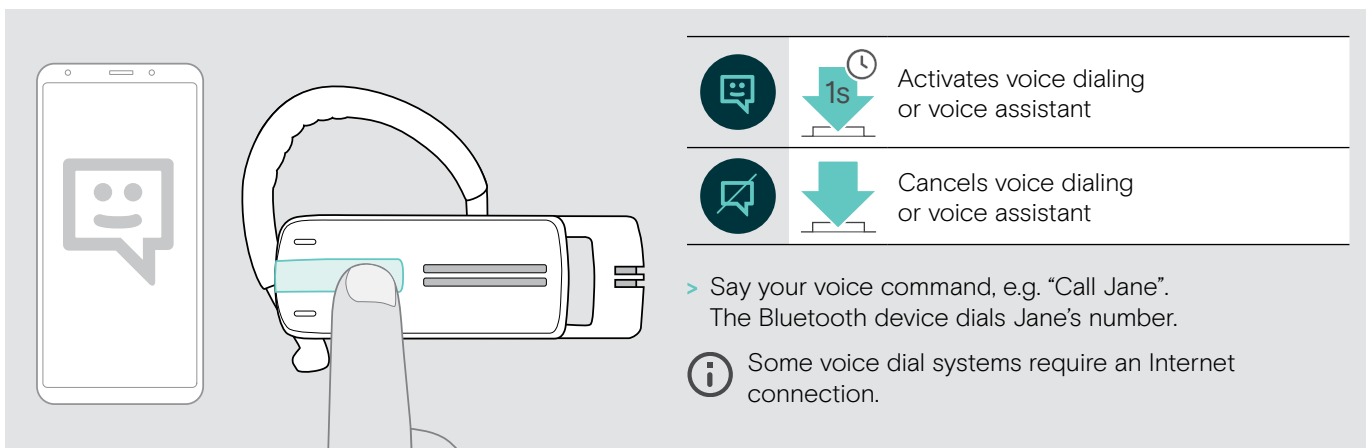

## Managing multiple calls

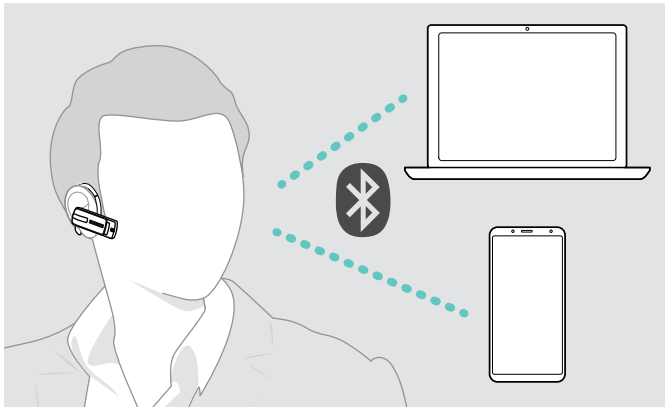

You can use the headset simultaneously with two connected Bluetooth devices (see page 7).

### Managing two calls

You can manage two calls:

- from either **two different** Bluetooth devices or
- from **one** Bluetooth device.

If you receive a call during an active call:

> Press the multi-function button:

Active call	2nd incoming call	Function
		Accepts the incoming call and ends the active call
		Accepts the incoming call and puts an active call on hold (toggling – phone dependent)
		Rejects the incoming call and continues the active call

If you put an active call on hold (toggling):

> Press the multi-function button:

Active call	2nd call put on hold	Function
		Ends the active call and makes the call on hold active (phone dependent)

## Maintaining the products and updating the firmware

### CAUTION

#### Liquids can damage the electronics of the product!

Liquids entering the housing of the device can cause a short circuit and damage the electronics.

- > Keep all liquids far away from the product.
- > Do not use any cleansing agents or solvents.

### Cleaning the products

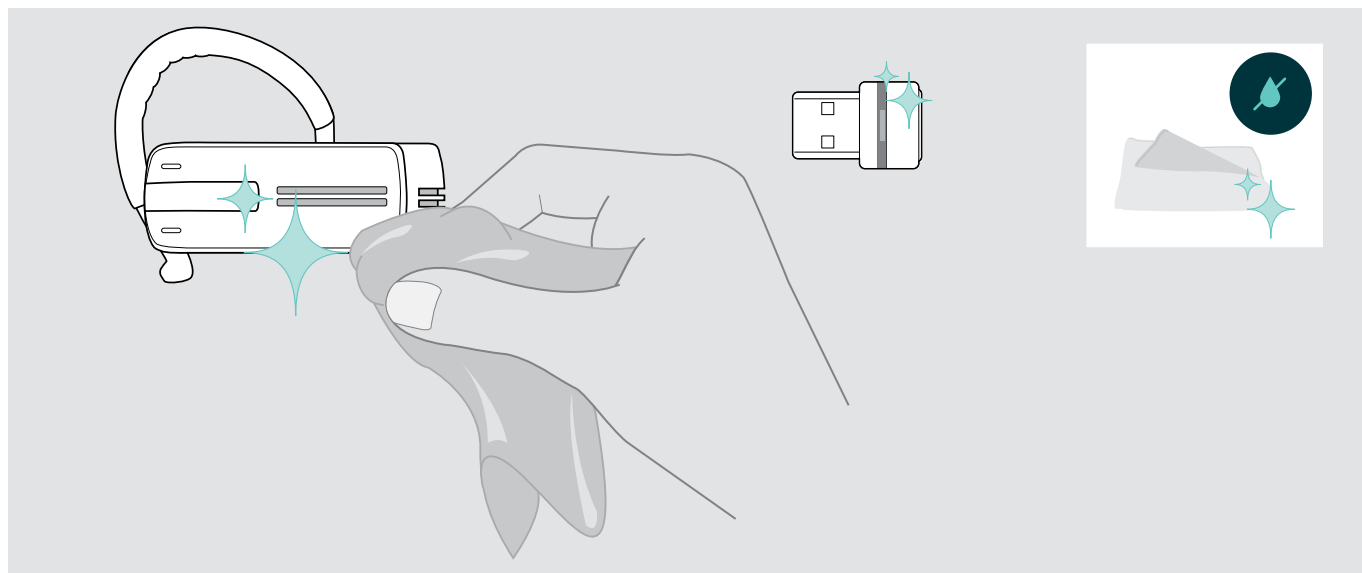

- > Only use a dry cloth to clean the product.

## Updating the firmware of the products

To update the installed firmware:

- > Install the free of charge **EPOS Connect** software (see page 10).

### Updating the firmware of the headset

To update the firmware, only one product may be connected at a time:

- > Disconnect all other products before starting the update.

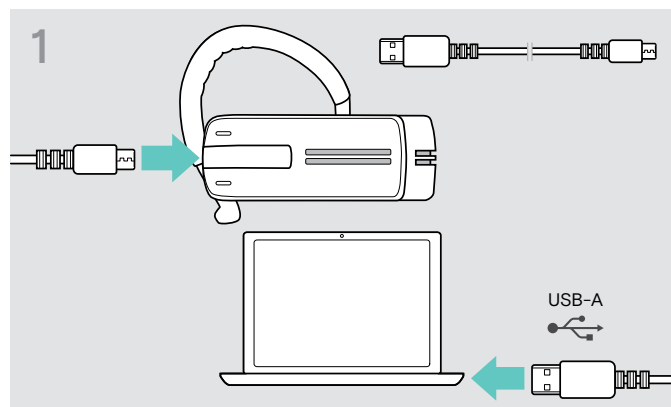

- > Use a USB cable with mini USB plug to connect the headset to your computer.

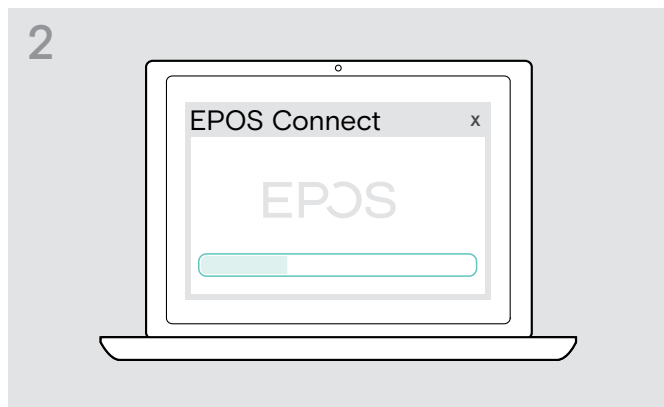

- > Start **EPOS Connect**.  
**EPOS Connect** checks if the installed firmware is the latest version available on the EPOS server. If required, upgrade to the latest version.

### Updating the firmware of the Bluetooth dongle

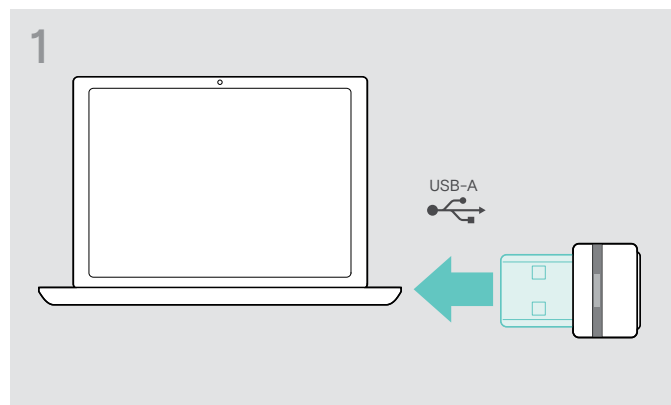

- > Plug the Bluetooth USB dongle into the USB port of your computer.



- > Start **EPOS Connect**.  
**EPOS Connect** checks if the installed firmware is the latest version available on the EPOS server. If required, upgrade to the latest version.

## If a problem occurs ...

Problem	Possible cause	Solution	Page
Headset cannot be switched on	The rechargeable battery is flat.	> Recharge the rechargeable battery.	6
No audio signal	The headset is not paired with the mobile phone.	> Check if the headset is paired. If necessary, pair the headset again.	7
	The volume is adjusted too low.	> Increase the volume.	15
	The headset is switched off.	> Switch the headset on.	13
Headset cannot be paired	The pairing does not work.	> Check if your Bluetooth device supports the HF or HS profile.	-
	The mobile phone is switched off.	> Switch the mobile phone on.	-
No voice prompts announced (beeps only)	The voice prompts are disabled.	> Enable the voice prompts.	16
Headset does not react to any button press	The operation of the headset is faulty.	> Reset the headset to the factory default settings.	23
Connection establishment takes a long time	Bluetooth device 1 is not available.	> Toggle between your two Bluetooth devices.	13
No Bluetooth connection via dongle BTD 800	Dongle not inserted correctly in the computer	> Plug in the dongle again.	9
	Dongle and Presence Grey not connected	> Pair the dongle and your Presence Grey headset (Pairing).	9
Dongle BTD 800 does not accept new devices (Pairing)	Dongle's pairing list disturbed	Clear the list of previously paired devices: > Press and hold the dongle's button for 3 seconds to enter pairing mode. The LED alternately flashes blue and red. > Double press the dongle's button. The LED flashes purple three times. The pairing list is cleared.	-

If a problem occurs that is not listed in the above table or if the problem cannot be solved with the proposed solutions, please contact your local EPOS partner for assistance.  
To find an EPOS partner in your country, search at [eposaudio.com](http://eposaudio.com).

### Restoring factory default settings (Reset)

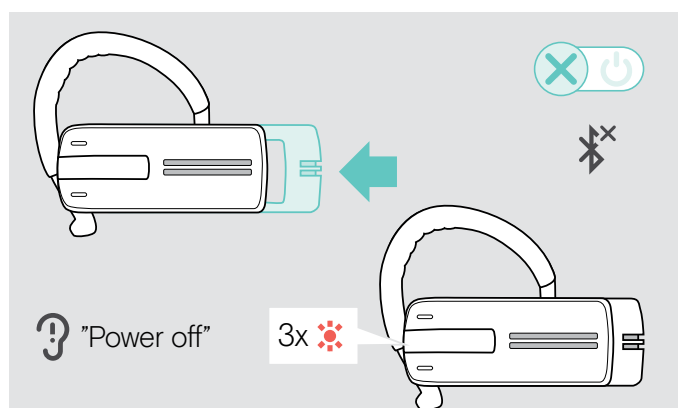

> Gently push the on/off power slide towards the headset. The voice prompt "power off" is announced in the headset and the LED flashes red 3 times. The headset ends the call and switches off.

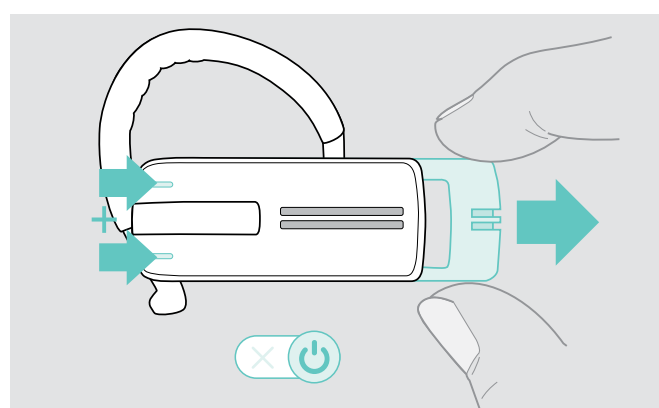

> Keeping both Volume buttons pressed, gently pull the on/off power slide away from the headset. The LED flashes 3 times purple and then alternately blue and red. The headset tries to pair with the Bluetooth devices (see page 7)



# EPOS

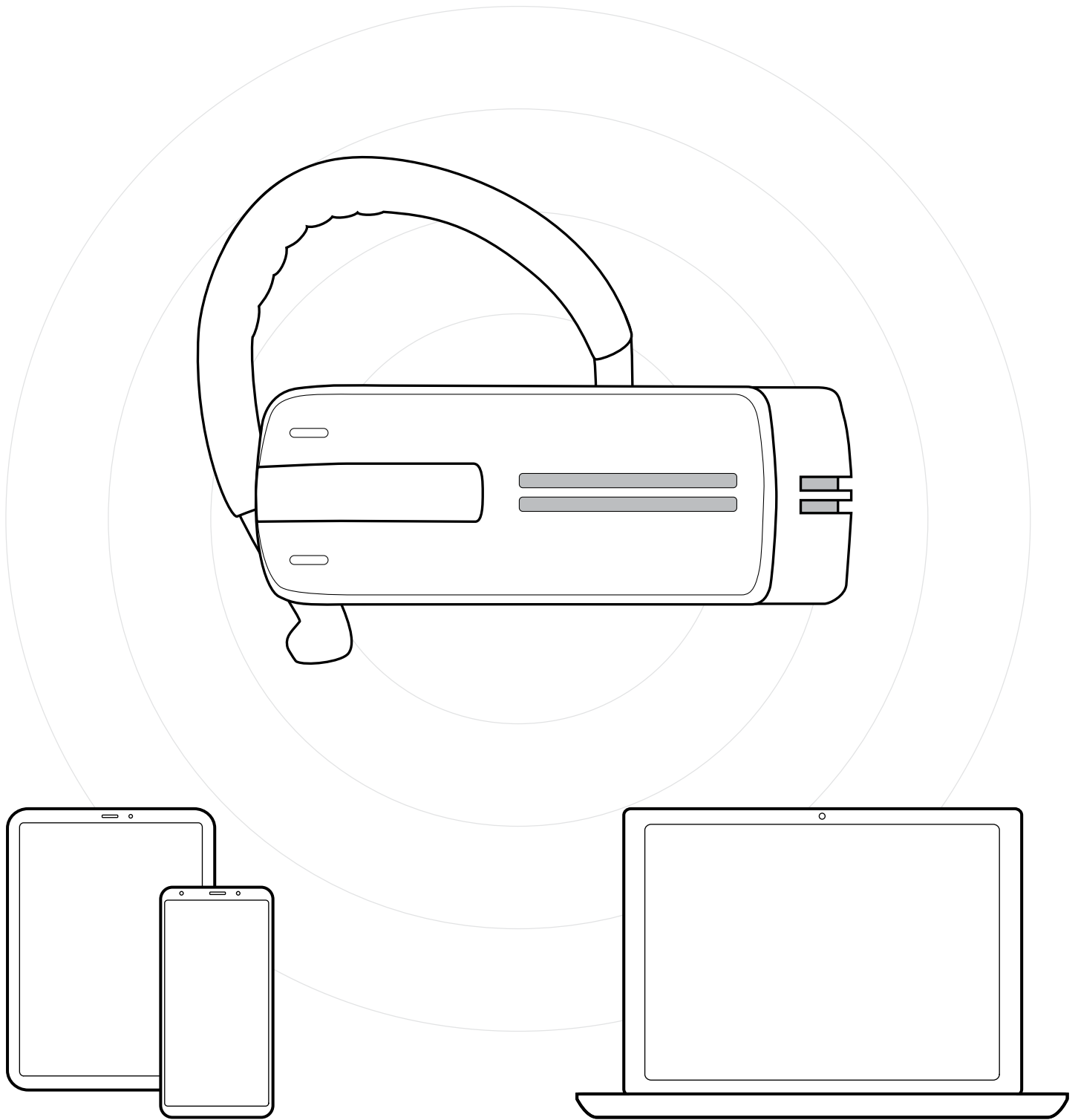

DSEA A/S

Kongebakken 9, DK-2765 Smørum, Denmark  
eposaudio.com